

Worldwide Pollution Control Association

Duke Energy Seminar
September 3 – 5, 2008
Concord, NC



Visit our website at www.wpca.info

W
P
C
A

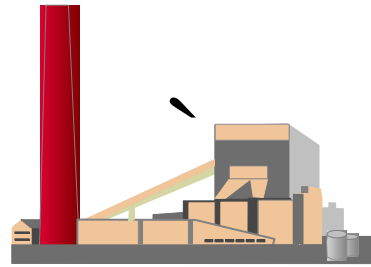

Fundamentals of Troubleshooting an ESP with an Oscilloscope

AEPSC
Russ Ridgeway



TEK THS-720 Scope Face

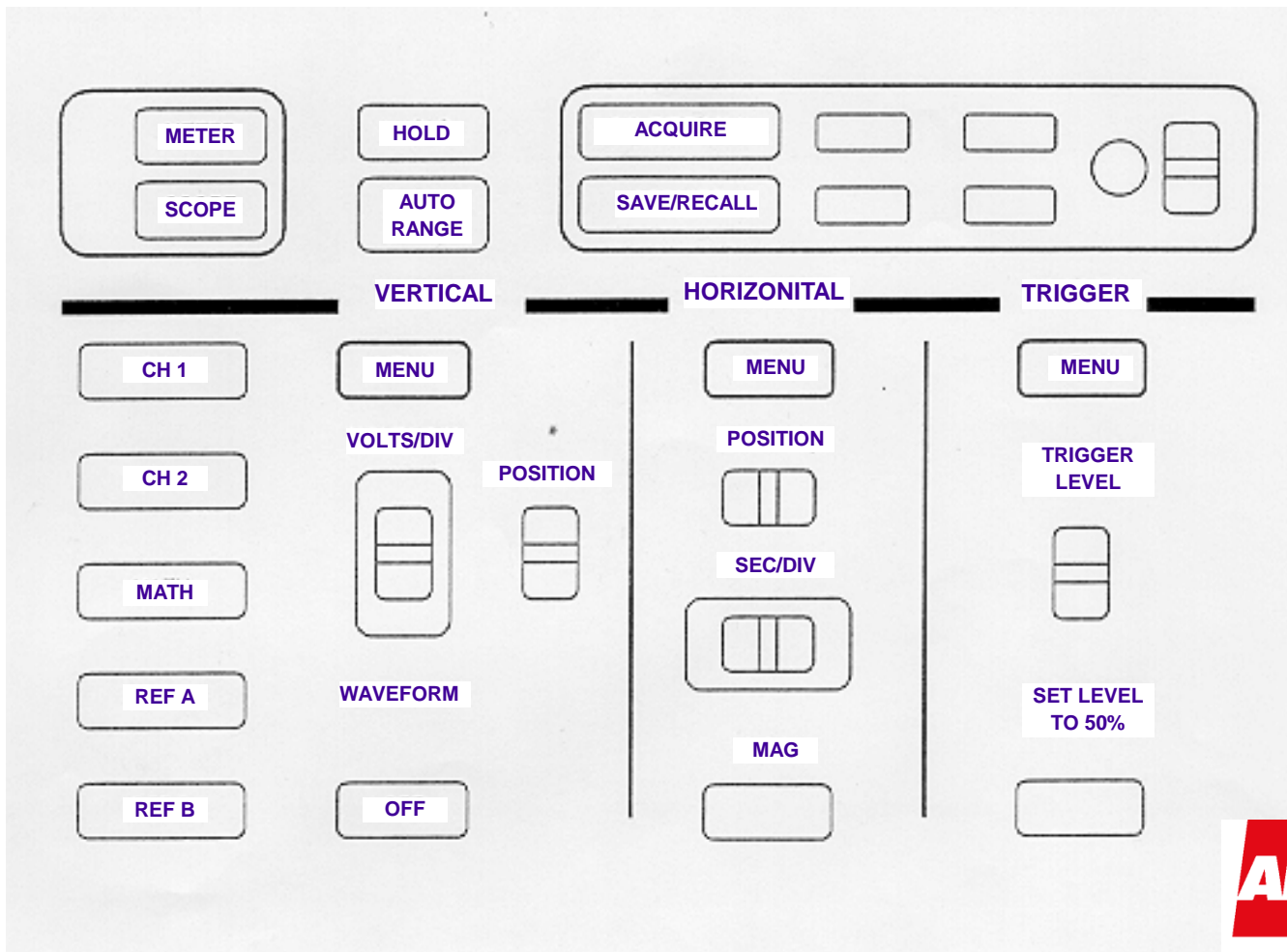

Typical AVC Circuit

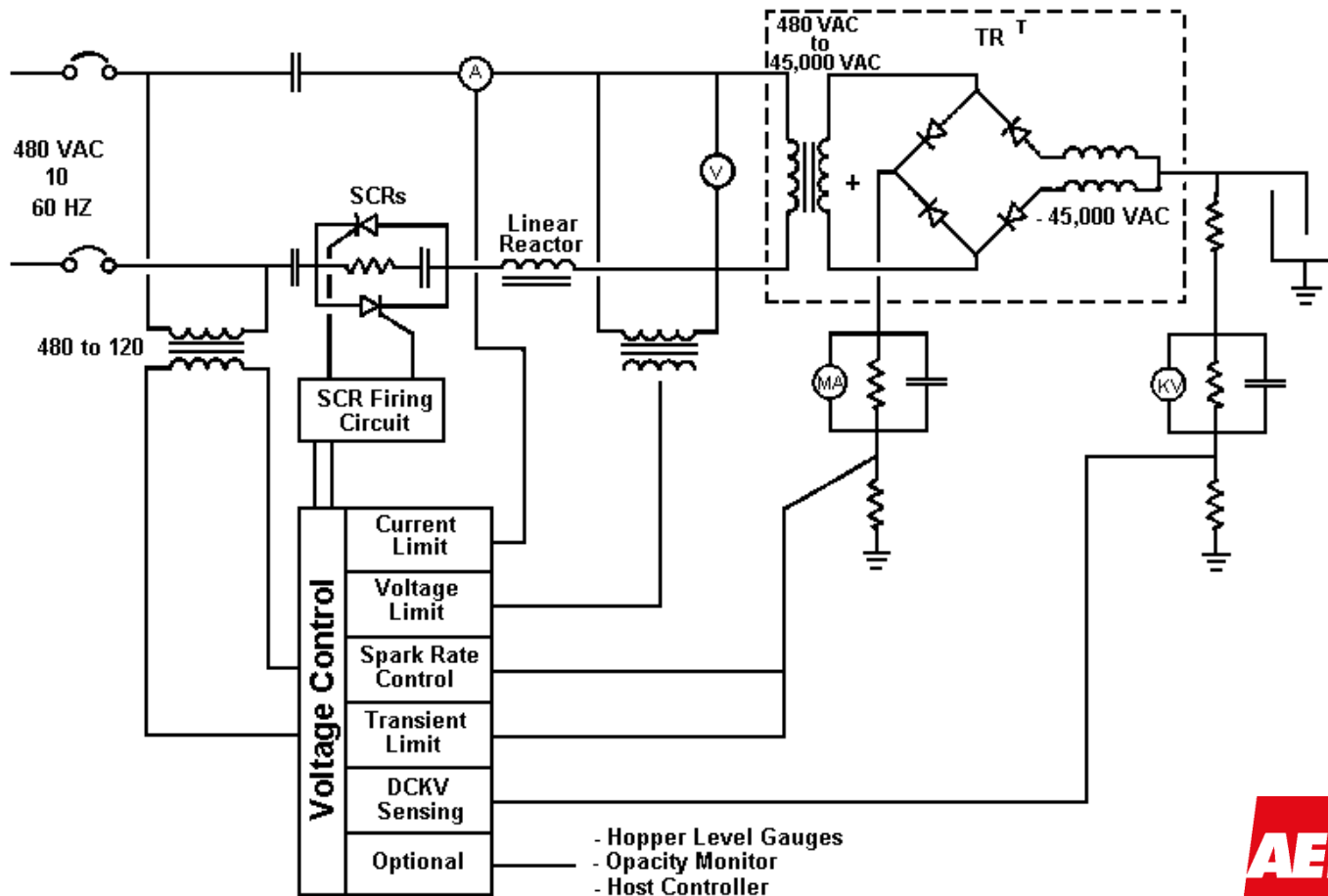

Primary Voltage

The "primary voltage" waveform is a chopped or pulsed sinusoidal waveform. It has been altered by the gating (turning on and off) of the SCRs.

Typically the waveform is not an actual representation of the actual voltage, because AC noise is suppressed on the signal.

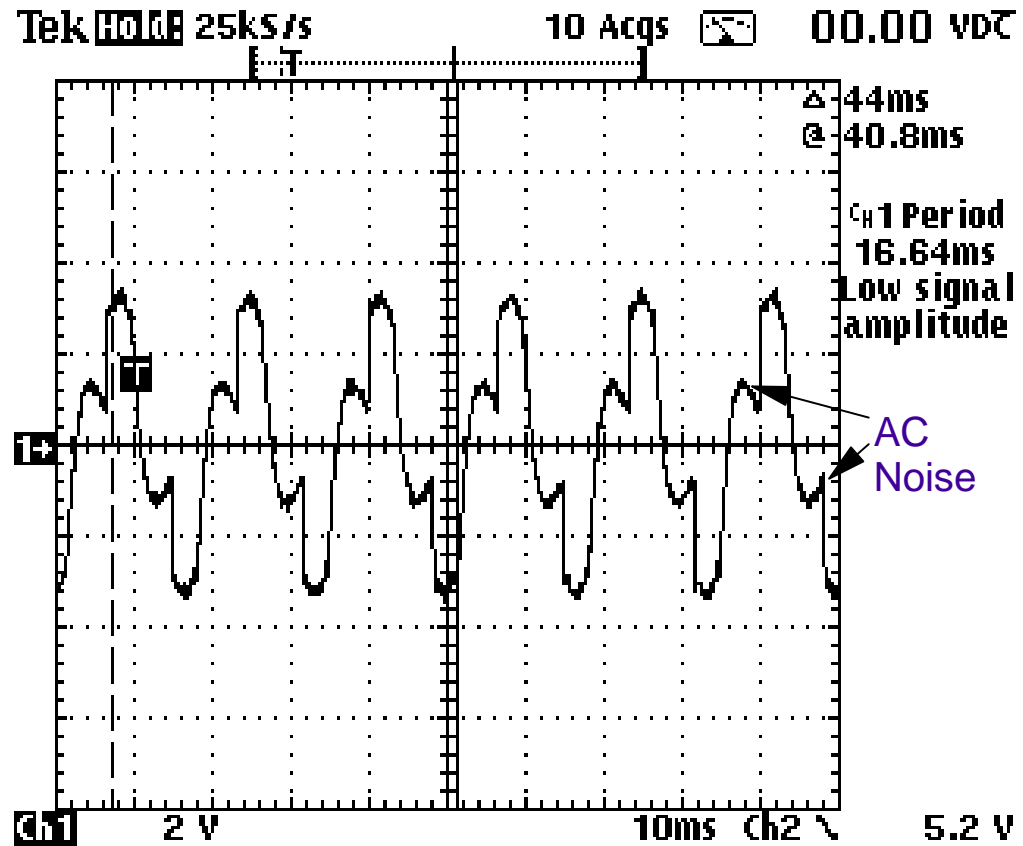

Primary Current

The "primary current" waveform is a chopped sinusoidal waveform. It too has been altered by the gating of the SCRs. Here the off times are easily noted.

Typically the waveform originates from the current transformer and is normally an actual (clean) representation of the current.

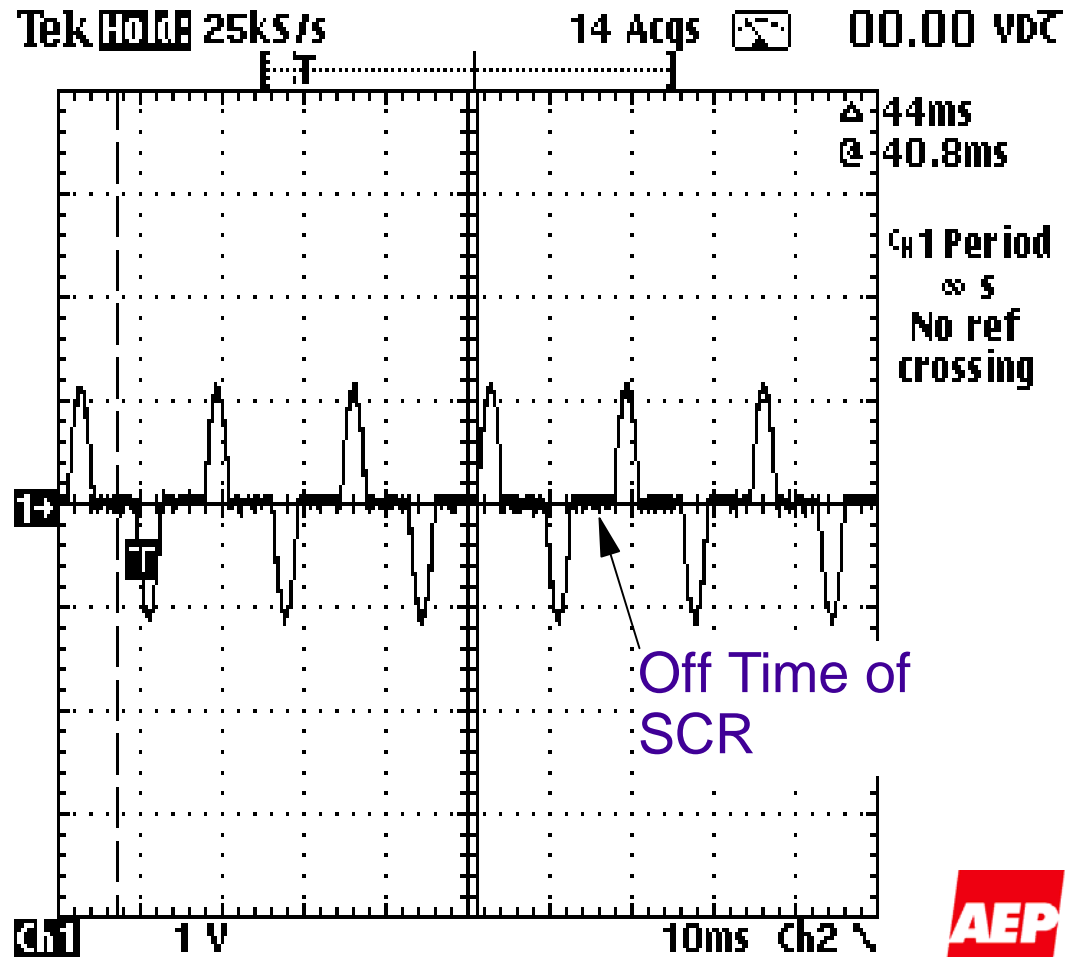

PRO SERVSM

Secondary Voltage (true negative waveform)

The "secondary voltage" waveform is a saw tooth with sharp drops to zero when a spark occurs. The collapse is upward because the signal is a negative DC value.

The signal is a saw tooth because the ESP acts as a capacitor and decays between half cycles.

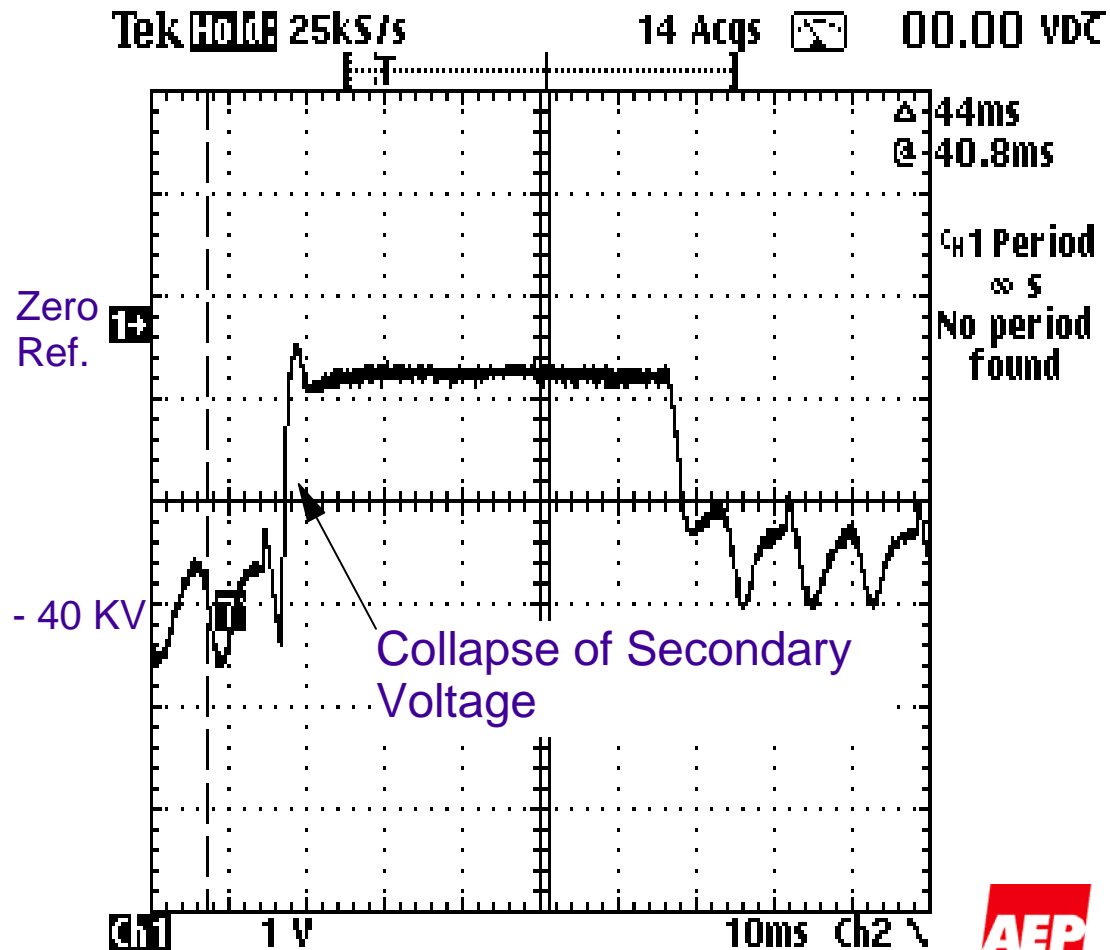

PRO SERVSM

Secondary Voltage (shown inverted)

The "secondary voltage" or KV waveform in this view is inverted. In this format the collapse is downward because the signal is a negative DC is represented as a positive value.

AEP typically displays the KV as an inverted signal, because it is easier to relate a collapse in voltage to a drop.

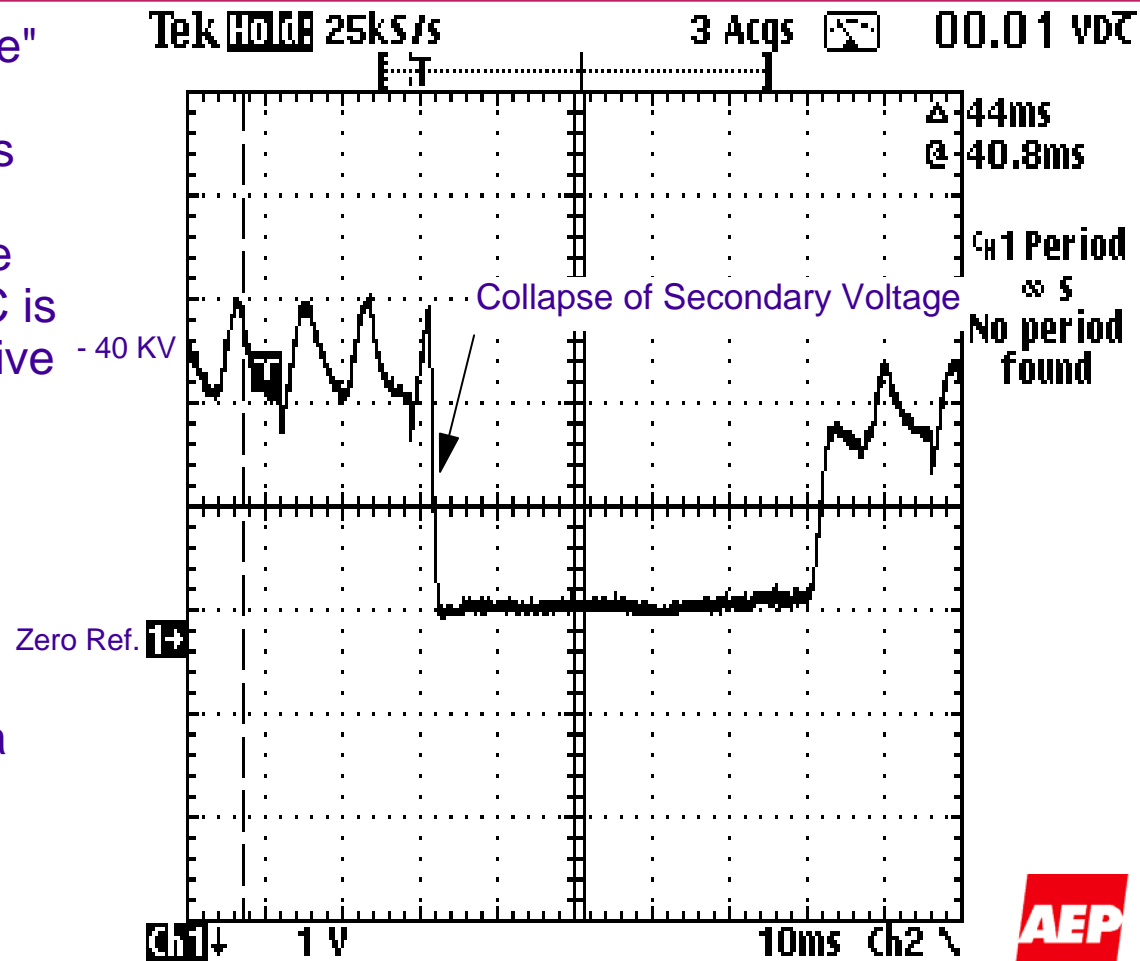

Secondary Current

The "secondary current" waveform is positive half cycle pulses. The pulses should occur every 8.33 mS since it originates from a rectified 60 cps input.

There are 2 half cycles per cycle.

$$\frac{1 \text{ Second}}{2 \times 60 \text{ Cycles}} = 8.33 \text{ mS}$$

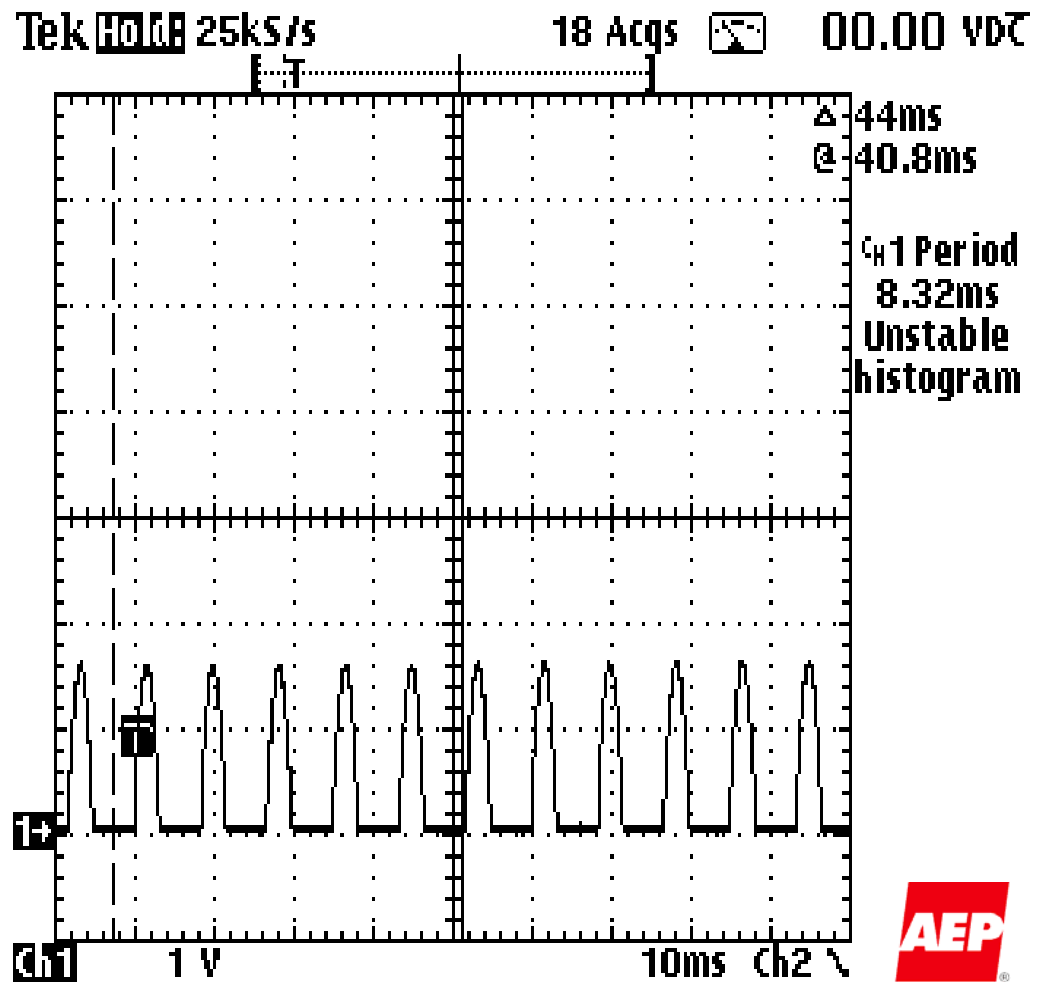

PRO SERVSM

AVC Connection Points when Troubleshooting with a Scope

Manufacturer	Secondary mA	Secondary KV	Primary Current	Primary Voltage	Gate Signal	Other
ABB/Flakt EPIC I	33/34	29/32	N/A	N/A	LC 21/22 LC 23/24	Supl. Gate Firing Card 7/8 & 9/10
ABB/Flakt EPIC II	48/49	64/65	50/51	PT101	LC 53/54 LC 55/56	
ABB SIR A	48/49	64/65	50/51	66/67	LC 57/58 LC 59/60 LC 61/62 LC 63/64	Supl. Gate Firing Card 1/2, 3/4, 5/6 & 7/8
ABB SIR E	15/16	17/18	1/2	3 / 4	LC 27/28	Supl. Gate Firing Card 1/2 & 5/6
BHA SQ-300	Connector J3 13/6	Connector J3 10/6	Connector J3 9/6 or CT	Connector J3 13/11	Connector J2 9/10& 6/7	
FLS miljo PIAVS	GTU X-12 35/36	GTU X-12 36/37	N/A	GTU X-1 1 / 4	GTU X-15 5/6	
Forry 3000/6000	TB1 11/12	TB1 13/14	TB1 7/8	TB1 9/10	TB1 1 / 2 & 3 / 4	Zero X TB1 5/6
Forry 9000	(A) P2 7/8 or R10 (B)P2 11/12orR12	(A)P2 9/10 or R11 (B)P2 13/14orR32	P2 3 / 4 or R7	P2 5/6 or R8	P1 1 / 2 P1 3 / 4	Zero X P2 1 / 2

AVC Connection Points (con't)

Manufacturer	Secondary mA	Secondary KV	Primary Current	Primary Voltage	Gate Signal	Other
Lodge-Cottrell AVC IV SB	7/14	6/14	4/14	5/14	22/23	
NWL	TB1 5 to GND	TB1 3 to GND	TB1 2 to GND	TB1 1 to GND	J2 – 2/1 J2 – 5/4	
R/C	40/15	60/15	C 13/15	6/7 or PT	FM 5(G)/6 9(G)/8	Spark Sensing G SCR 501/15
UOP	2A/376 2B/376	1A/376 1B/376	CT 32/34 Low Signal	K5/K4	G1/K1 G2/K2	
Neundorfer	Logic Board TP6 or Interface Board TP5/TP6	A- LB TP7 or IB TP7/TP8 B –LB TP 8 or IB TP10/TP9	Logic Board TP2 or Interface Board TP4/TP3	Logic Board TP3 Interface Board TP1/TP2	SCR 1 Across R11 SCR 2 Across R12	Spark Sensing Logic Board TP9



PRO SERVSM

Scope Rules of Thumb

- Vertical - Channel #1
 - Secondary mA
 - DC coupled
 - Bottom Trace or Signal
 - Ground Reference
 - 1 division from bottom
 - 1 - 5 Volts/Div
- Trigger
 - Channel #1
 - On Increasing Value
 - Trigger Level - Variable
 - May need HF filter
- Vertical - Channel #2
 - Secondary KV
 - DC coupled
 - Top Trace or Signal
 - Ground Reference
 - Center or 5 divisions from bottom
 - 1 - 5 Volts/Div
 - Inverted
- Horizontal - Time
 - 10 mS/Div

Terms for Secondary Current

The terms used for a spark cycle are:

Steady state - operation prior to the spark (shown here as current limit)

Spark - a short circuit inside the ESP which disturbed the gases between the wire and plate.

Quench - a period of off time which allows the disturbed gas to be dissipated. (Typically 2 cycles)

Recovery - a series of half cycles where the ESP returns quickly to near prespark conditions. (Typically 4 half cycles)

Set Back / Spark Response - the differential between steady state and recovery operating level. (Typically 3 to 10%)

Slow Ramp / Rise Rate - the period of time it takes the control to return to prespark level. The angle is based on **set back** and **spark rate**. Spark rate should never be greater than 60 sparks/minute (typically 10-30 spm for inlet sets and 1-10 spm for outlet sets)

Fast Ramp - a feature on some new controls where the control ramps quickly to induce a spark if one has not occurred based on the preset spark rate. This allows for quicker recovery after an upset inside the ESP.

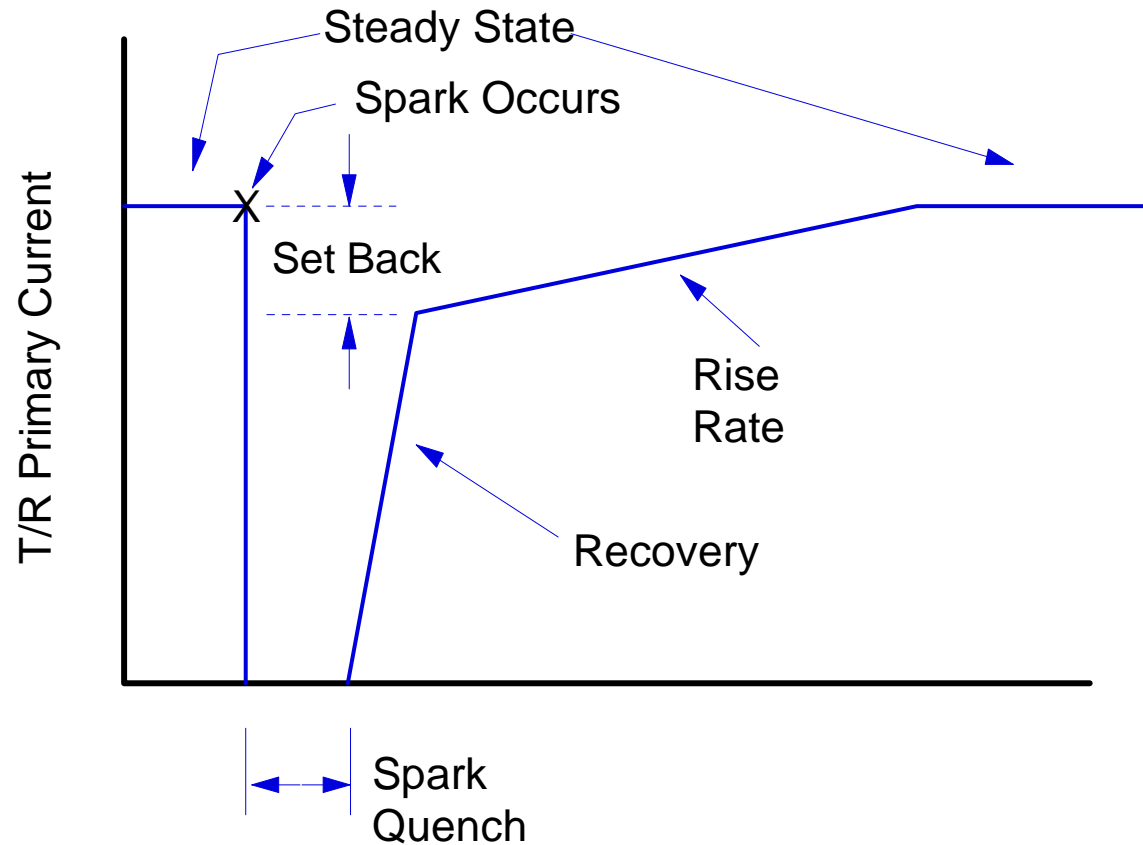

Typical Spark Response

The waveform is a typical trace of a spark response for both secondary voltage (top - shown inverted) and secondary current (bottom). Note the collapse of secondary voltage when the spark occurred. The control quenched and then quickly recovered to a level below the spark point.

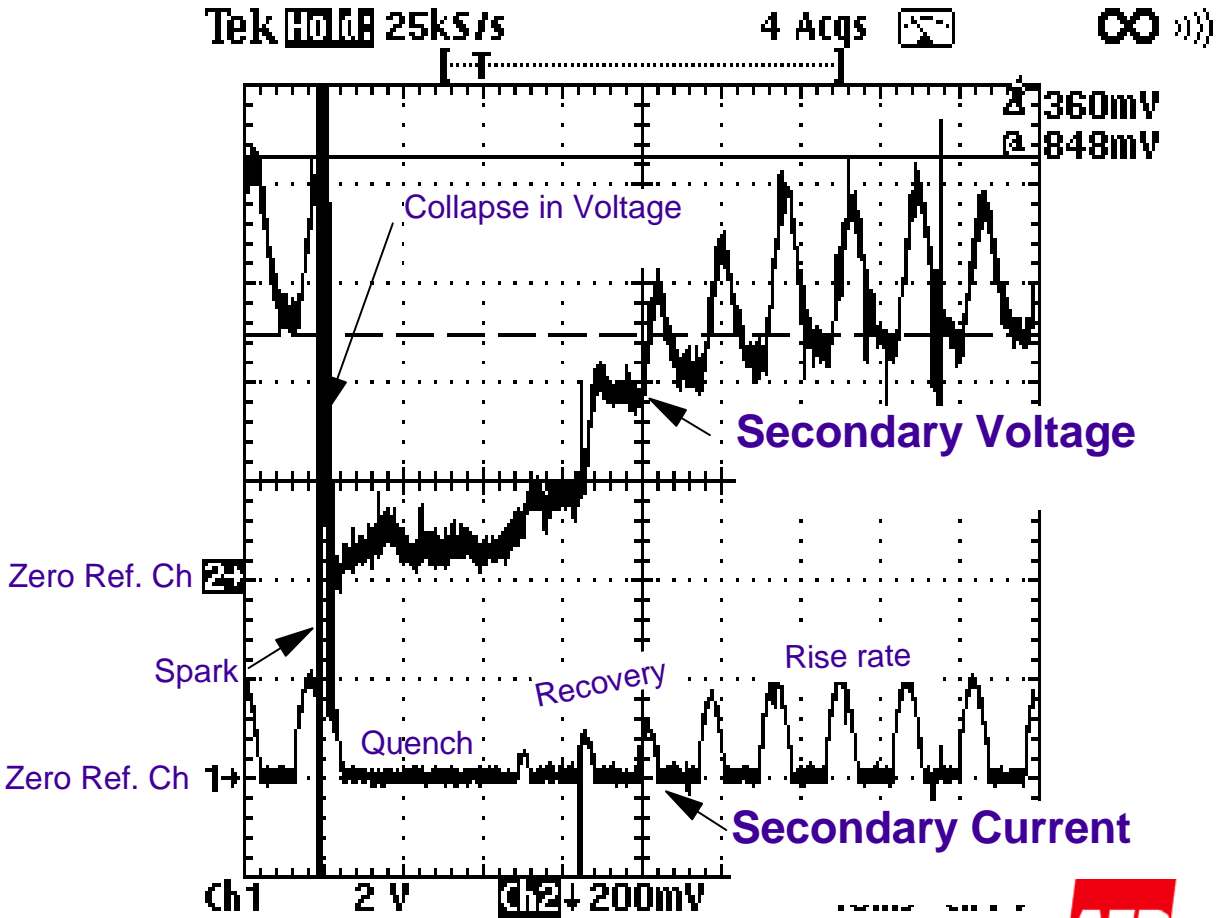

Spark Response w/o Spark

The waveform is a typical trace of a spark response for both secondary voltage (top - shown inverted) and secondary current (bottom). Note the collapse of secondary voltage when the spark occurred. The control quenched and then quickly recovered to a level below the spark point.

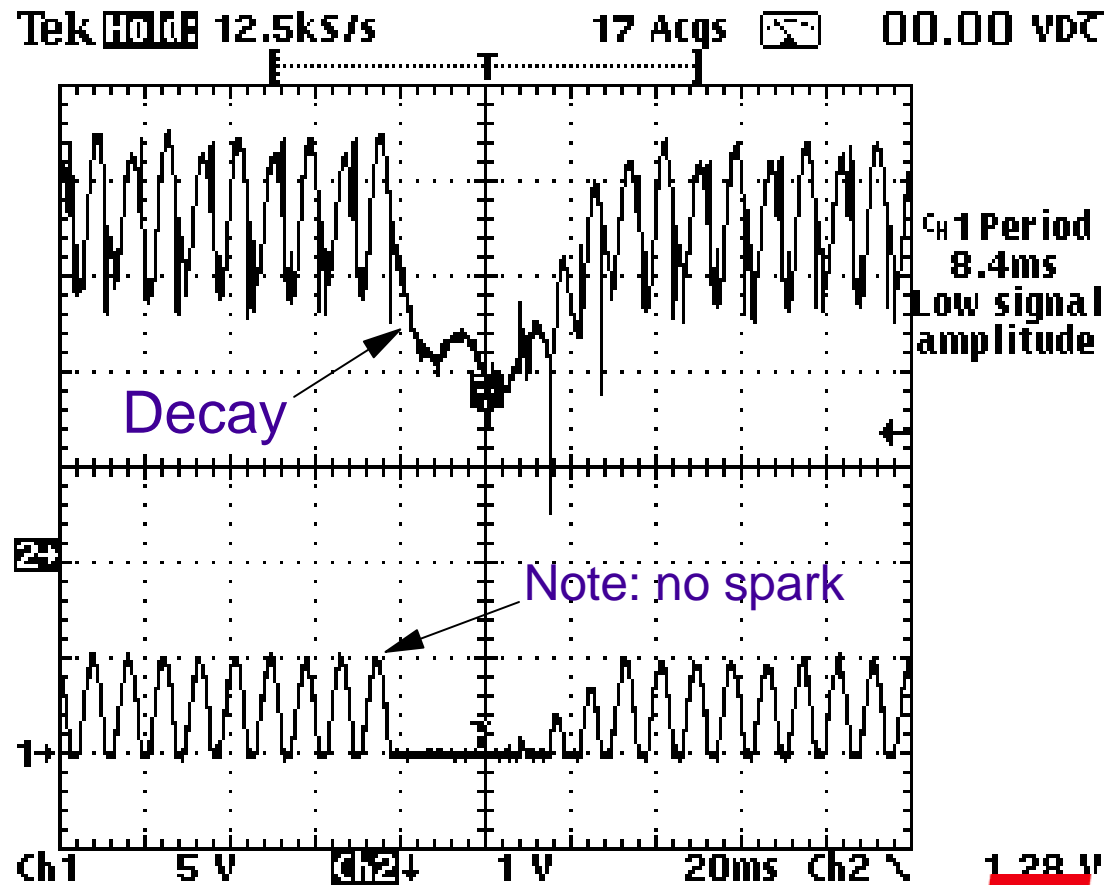

Typical Waveform vs. Back Corona

The two waveforms are photos of a spark response for both secondary voltage (top - shown inverted) and secondary current (bottom). Note the rise and leveling of secondary voltage after the spark in the upper photo after the spark occurred. This is the expected response after a spark.

The lower photo shows control setting where the secondary voltage rises but then drops as the current continues to increase. This is a sign that "back corona" or reverse ionization is present.

Scope Trace Showing A Typical Spark Response

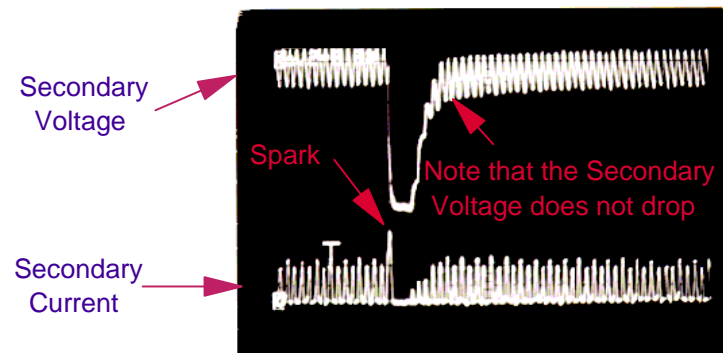

Scope Trace Showing Back Corona

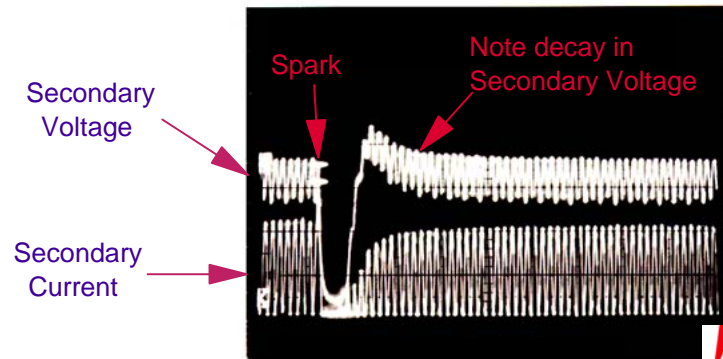

Additional Scope Traces of Back Corona

The two scope traces shown here also have signs of back corona. The upper trace has the classic decay in the trough of the KV signal indicating back corona. However it has a second symptom which is a spread between the peaks and troughs as time progresses. Both of the symptoms of back corona noted here are easily noted.

The lower scope trace is a little more difficult to observe the back corona symptoms. If one only looks at the post spark portion of the waveform, it is difficult to note the back corona. However if the steady state condition before the spark is evaluated, it can be seen that the spread between the peak and troughs have increased over time as well as the decay in the troughs. Both are signs that this bus section is in the early stages of back corona.

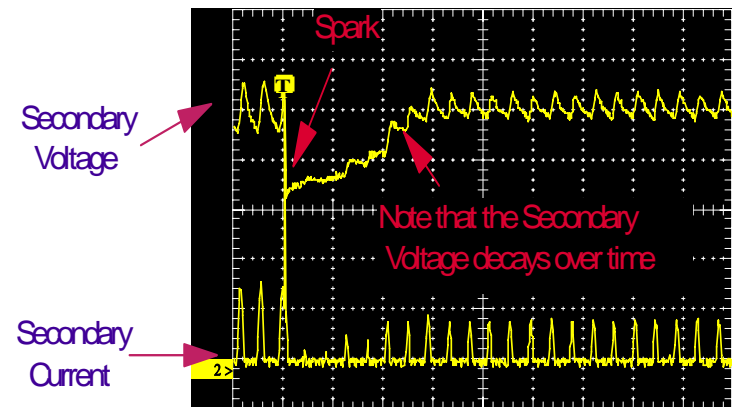
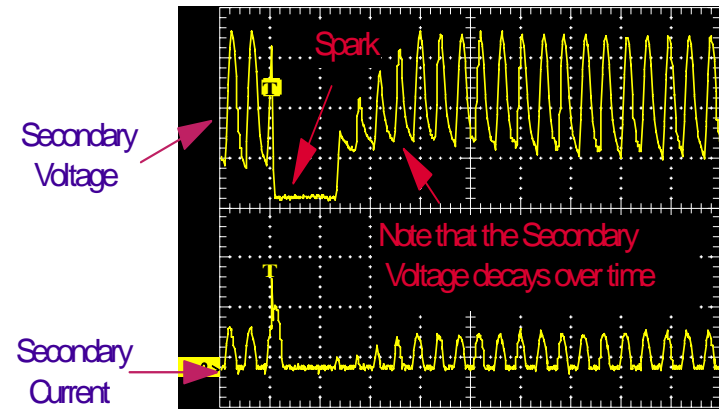

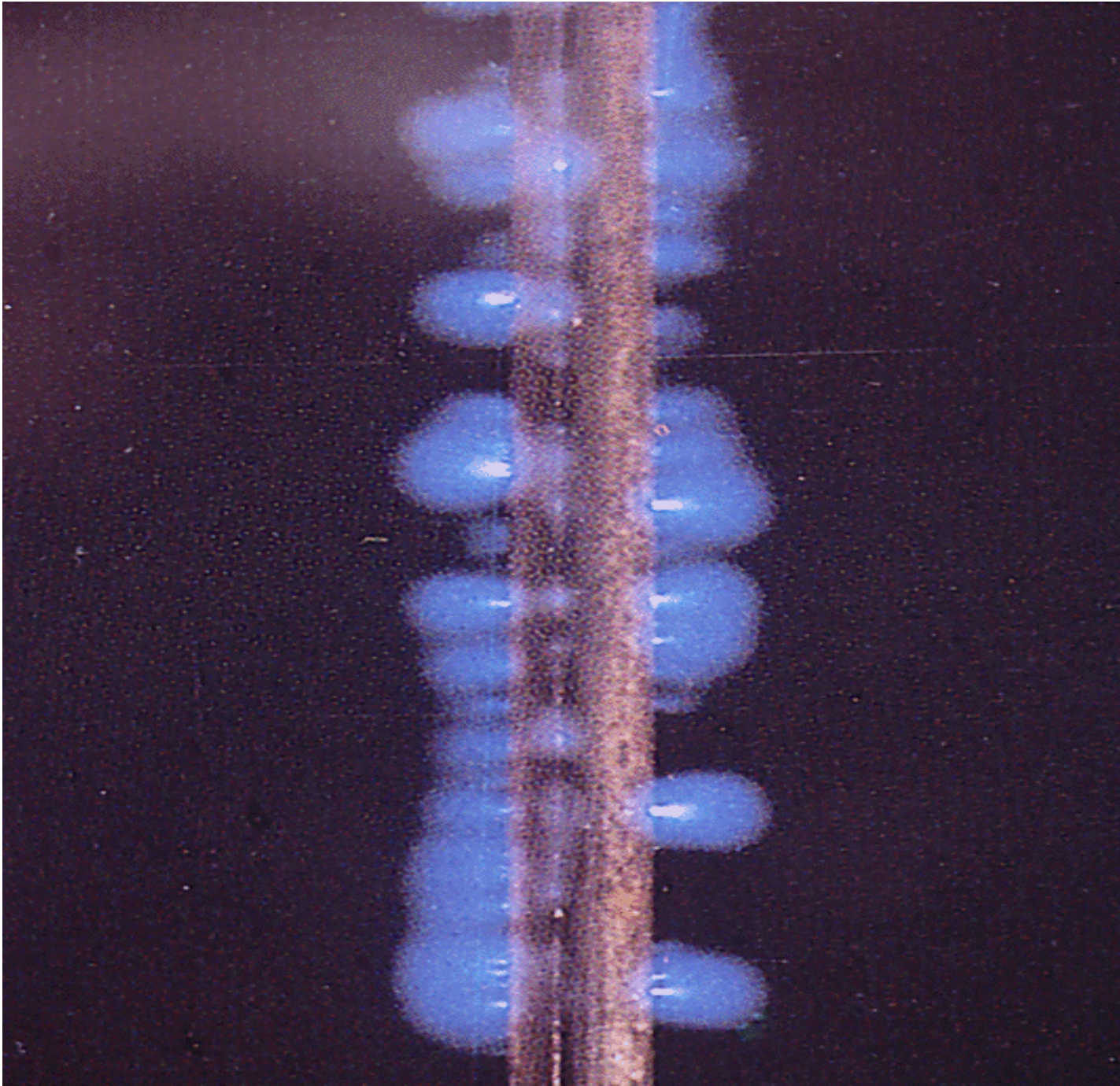

PRO SERV SM

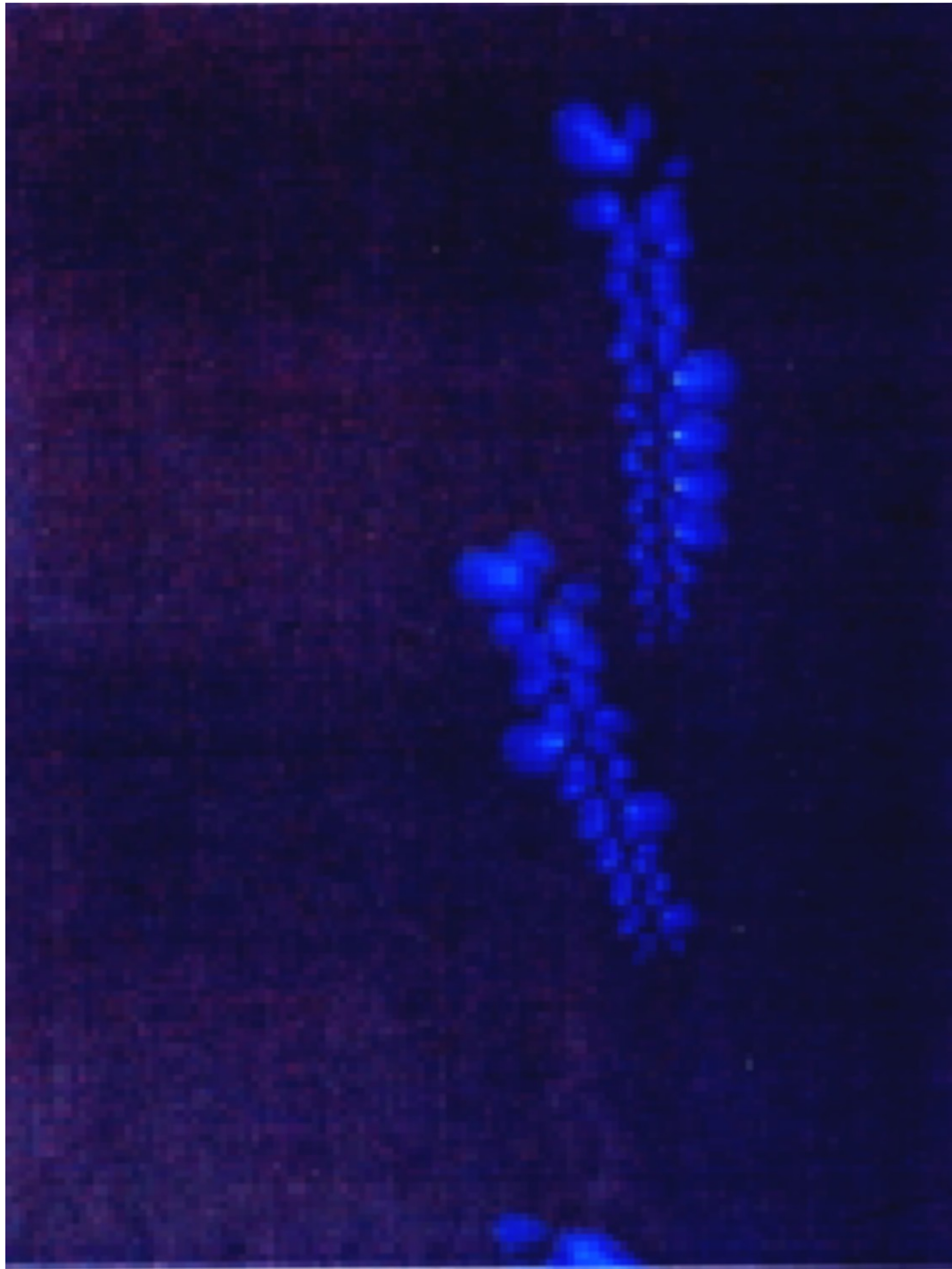

PRO SERVSM

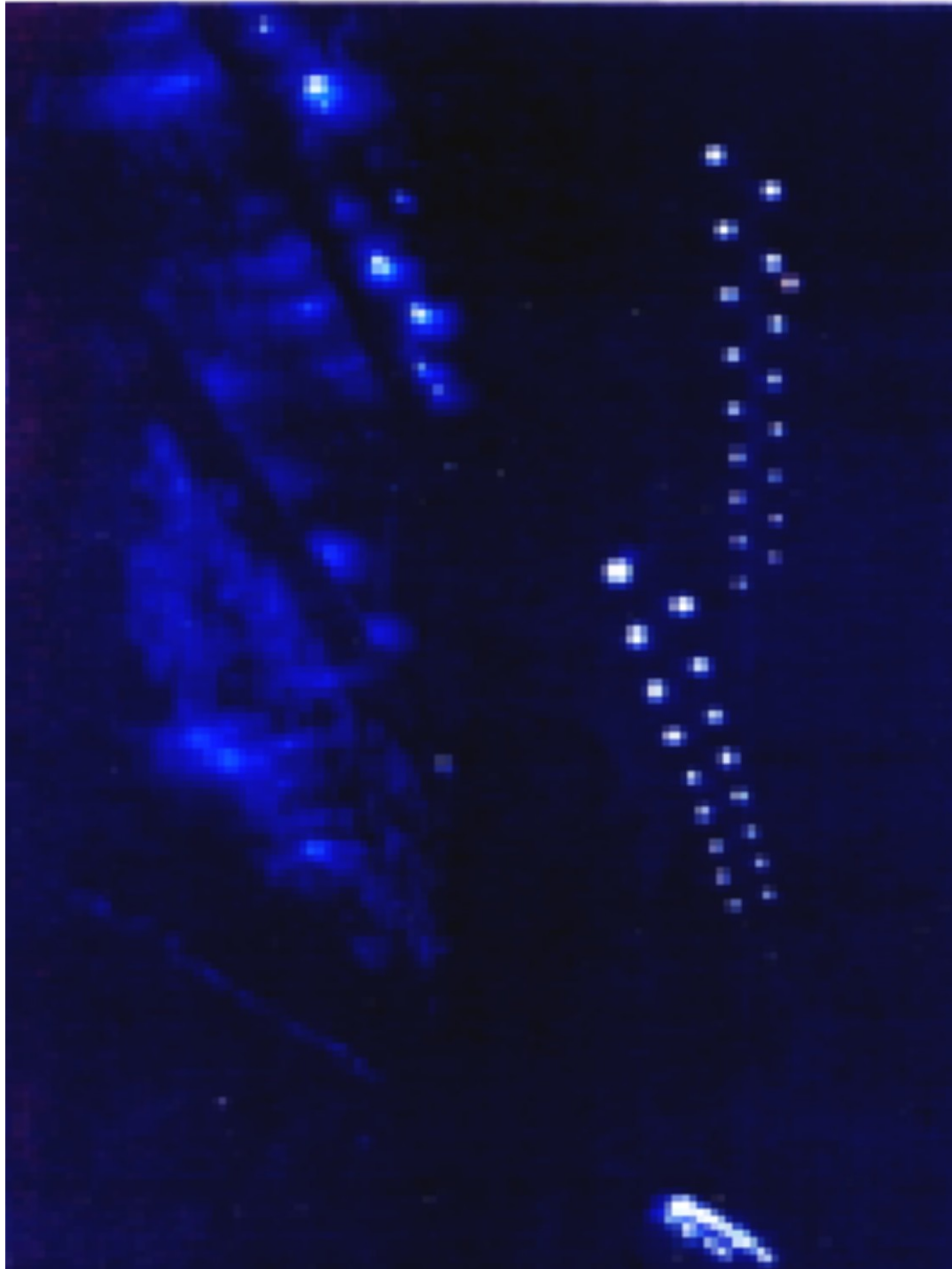

AEP[®]
PRO SERVSM

Ash Resistivity

- Fly ash resistivity/conductivity determined by two independent mechanisms
 - Volume resistivity/conduction
 - Surface resistivity/conduction
- Volume resistivity due to conduction through the bulk of the fly ash
- Volume resistivity dominates at higher temperatures

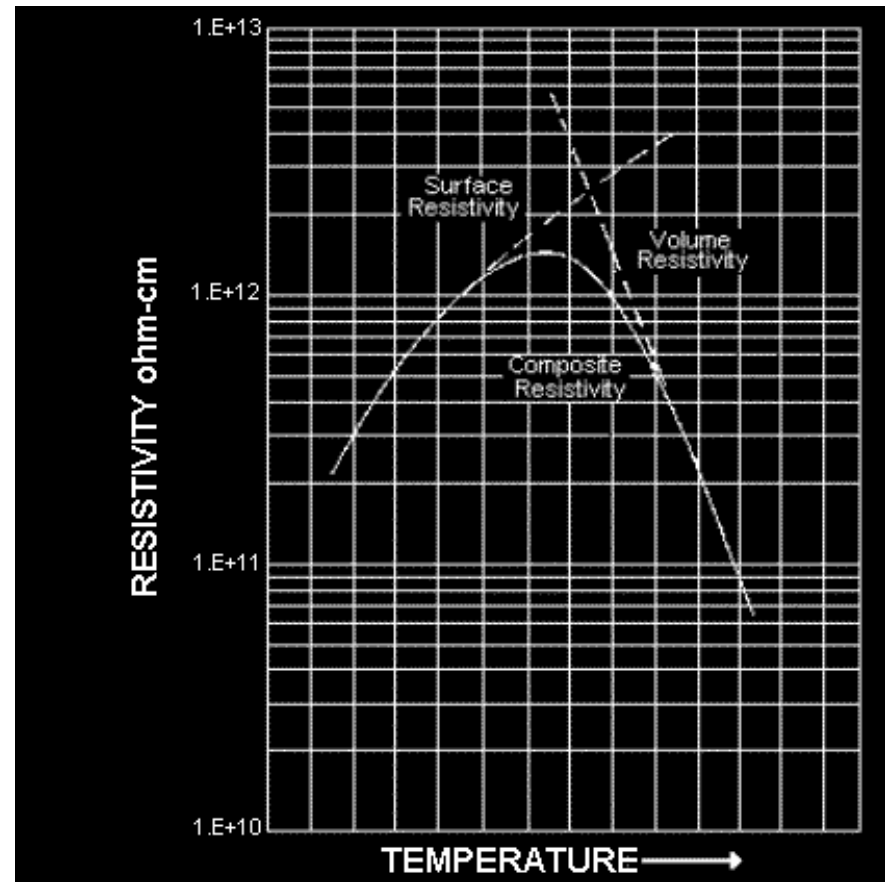

Analog Gates Signals

The waveforms are traces of the gate signals from an analog control. This control sends alternating signals to only the SCR which corresponds to that half cycle which can pass current.

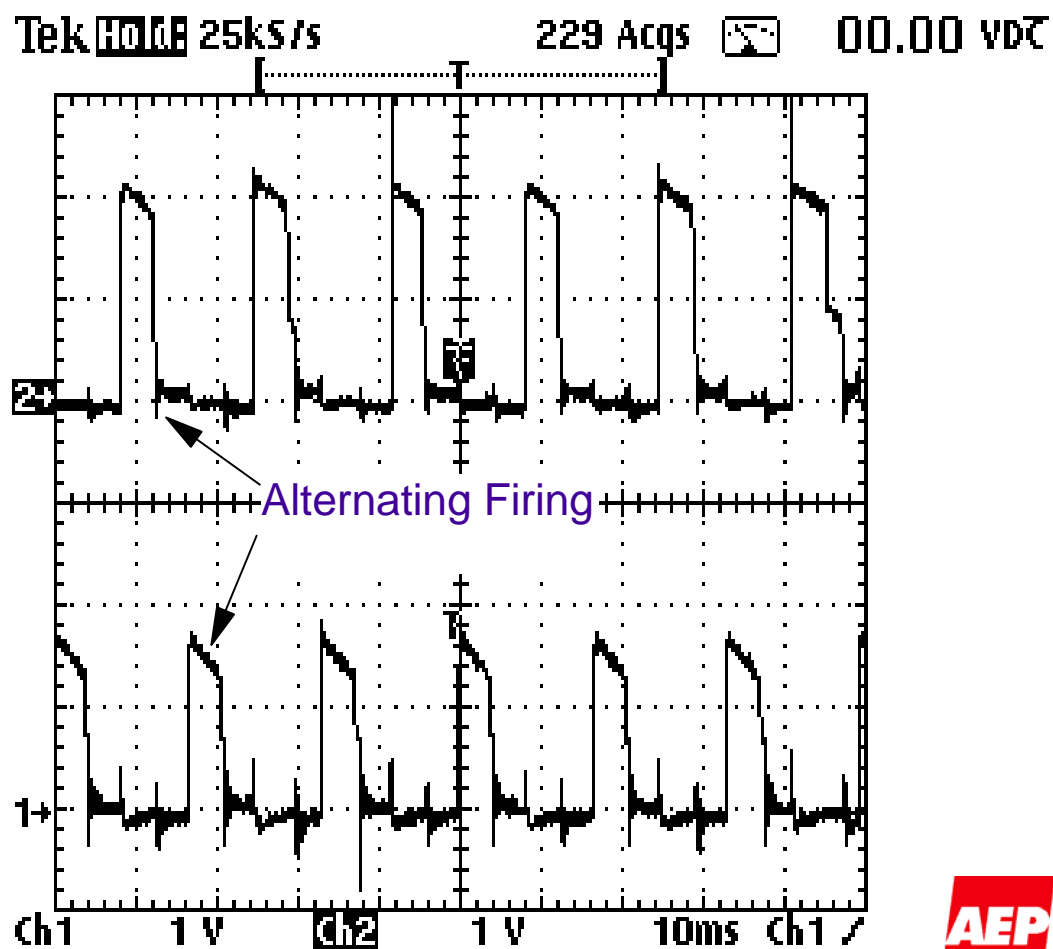

Digital Gates Signals

The waveforms are traces of the gate signals from a digital control. This control sends simultaneous signals to both SCRs although only the SCR which corresponds to that half cycle passes current.

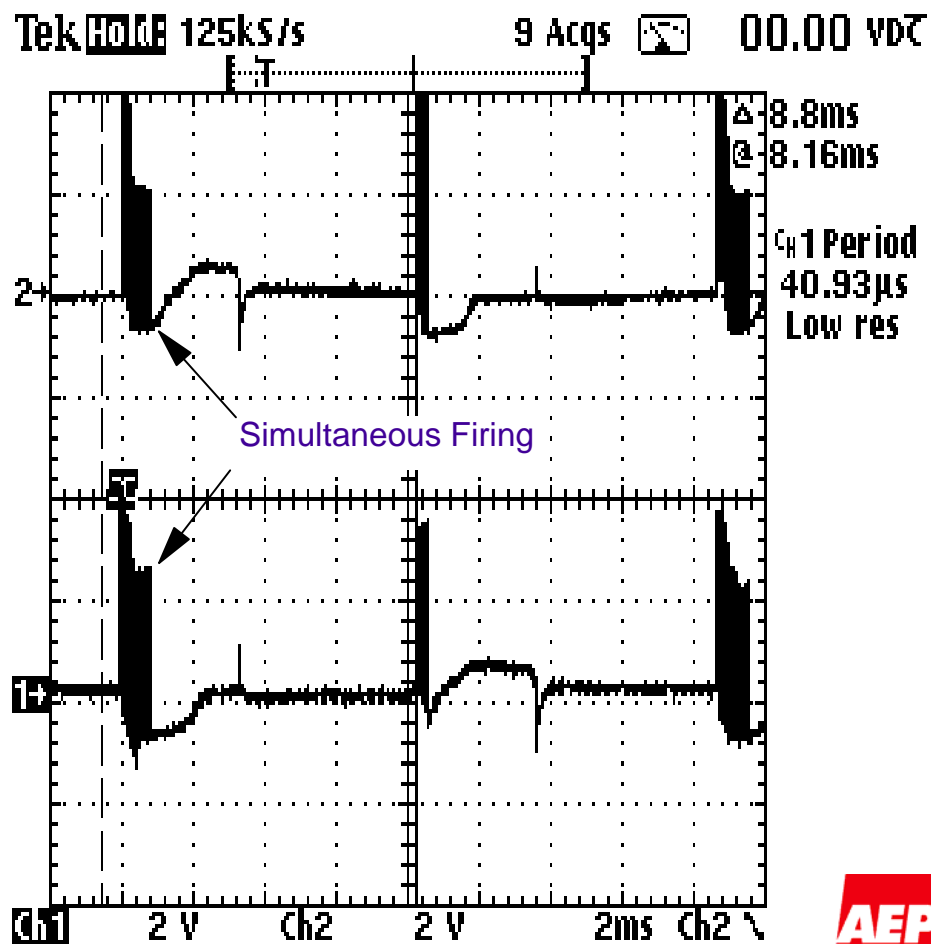
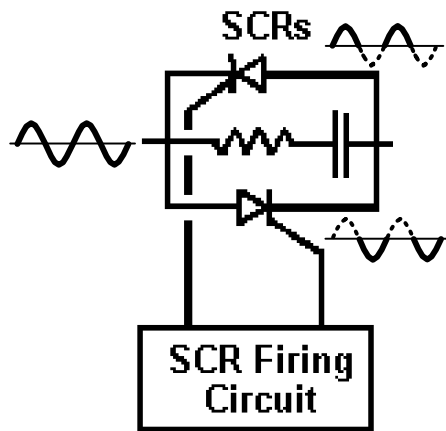

Secondary Signals w/only 1 SCR firing

The waveform is a trace of the secondary voltage and current. The significance of this trace is that the period of the half cycles is 16.67 mS. The period should be 8.33 mS. Since the secondary voltage signal corresponds to the current signal, one of the SCRs is not firing.

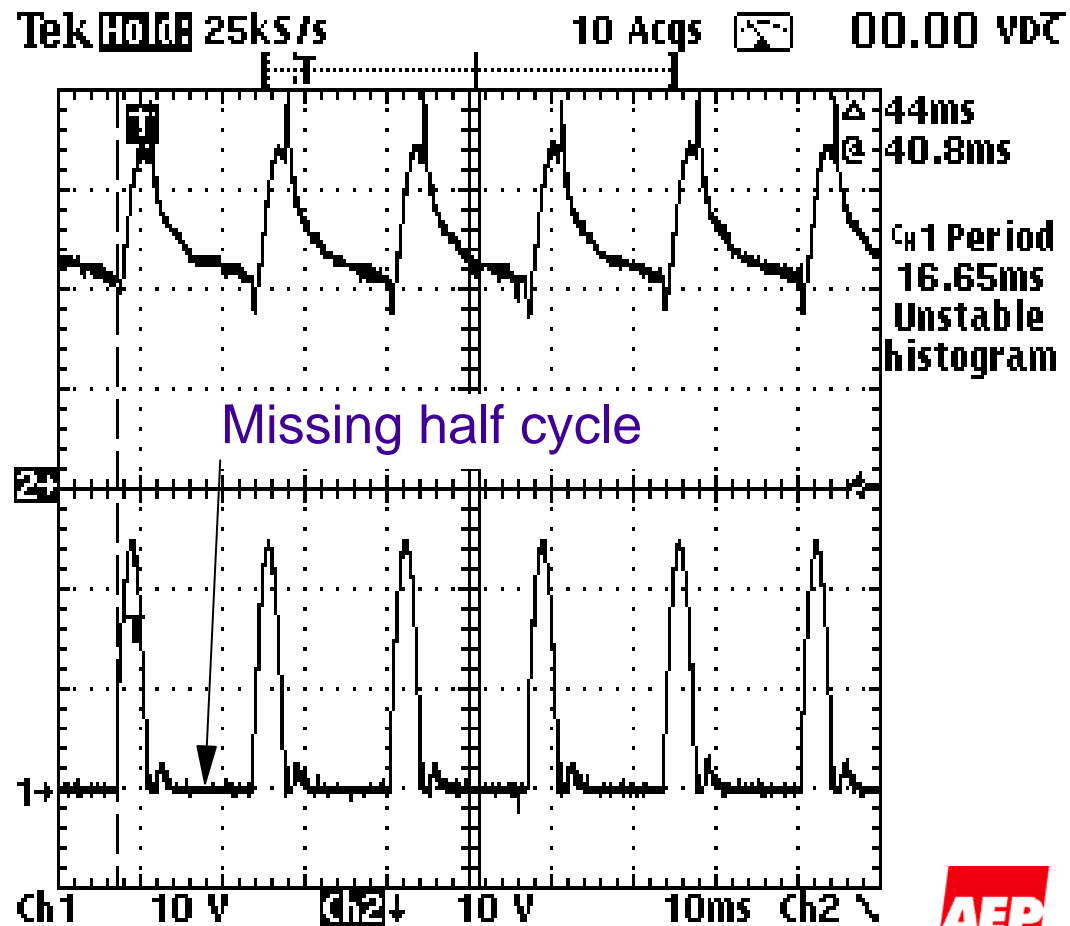

Secondary Current Feedback Missing One Leg of Bridge

The waveforms are traces of the secondary voltage and current. The significance of this trace is that the period of the current half cycles is 16.67 mS. The period should be 8.33 mS. However, the secondary voltage signal does not correspond to the current signal. Since there are voltage pulses where the current pulses are missing this indicate a signal feedback problem.

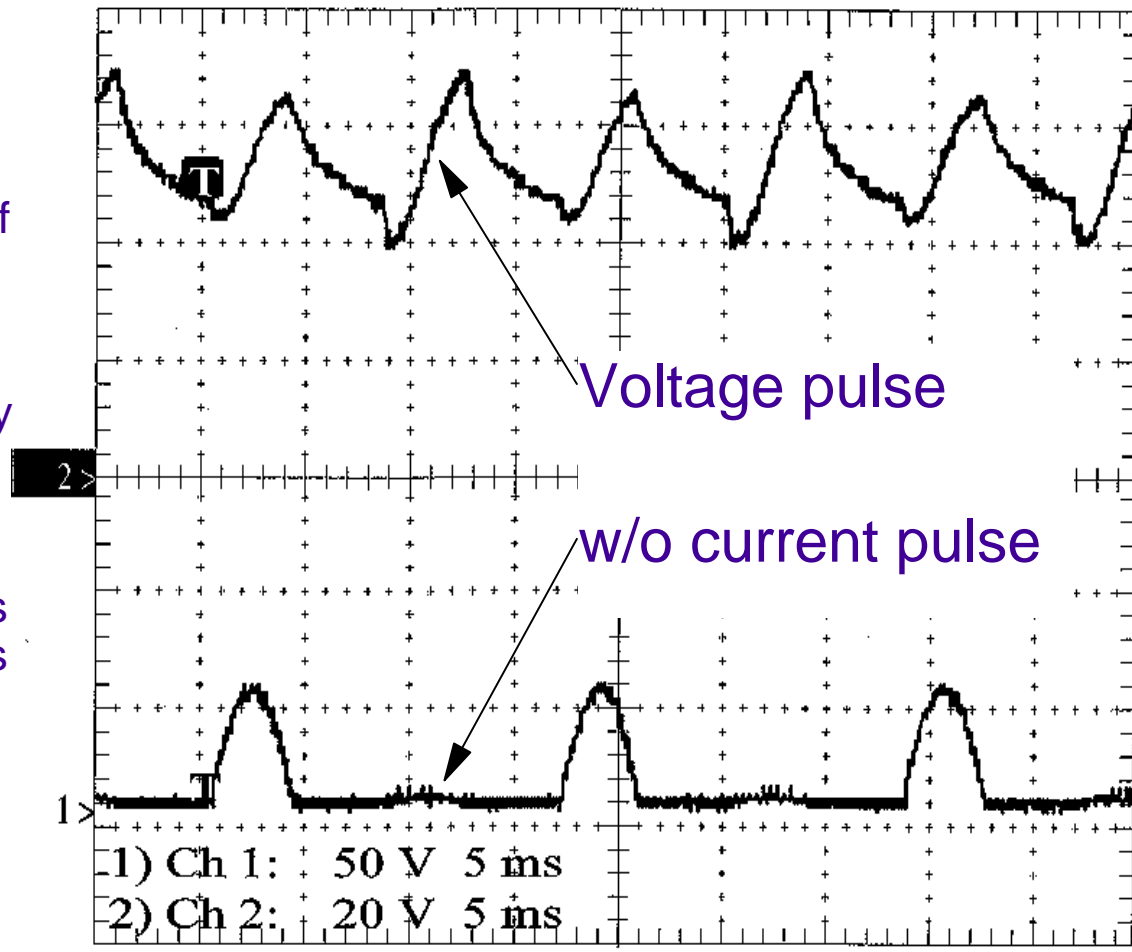

Analog Gate Pulse vs. Secondary Current with an SCR not firing

The waveforms are traces of an analog gate signal and current. The purpose of this trace is to aid in determining which SCR is not firing and if the control is telling the SCR to fire. This will identify what part of the circuit is a problem.

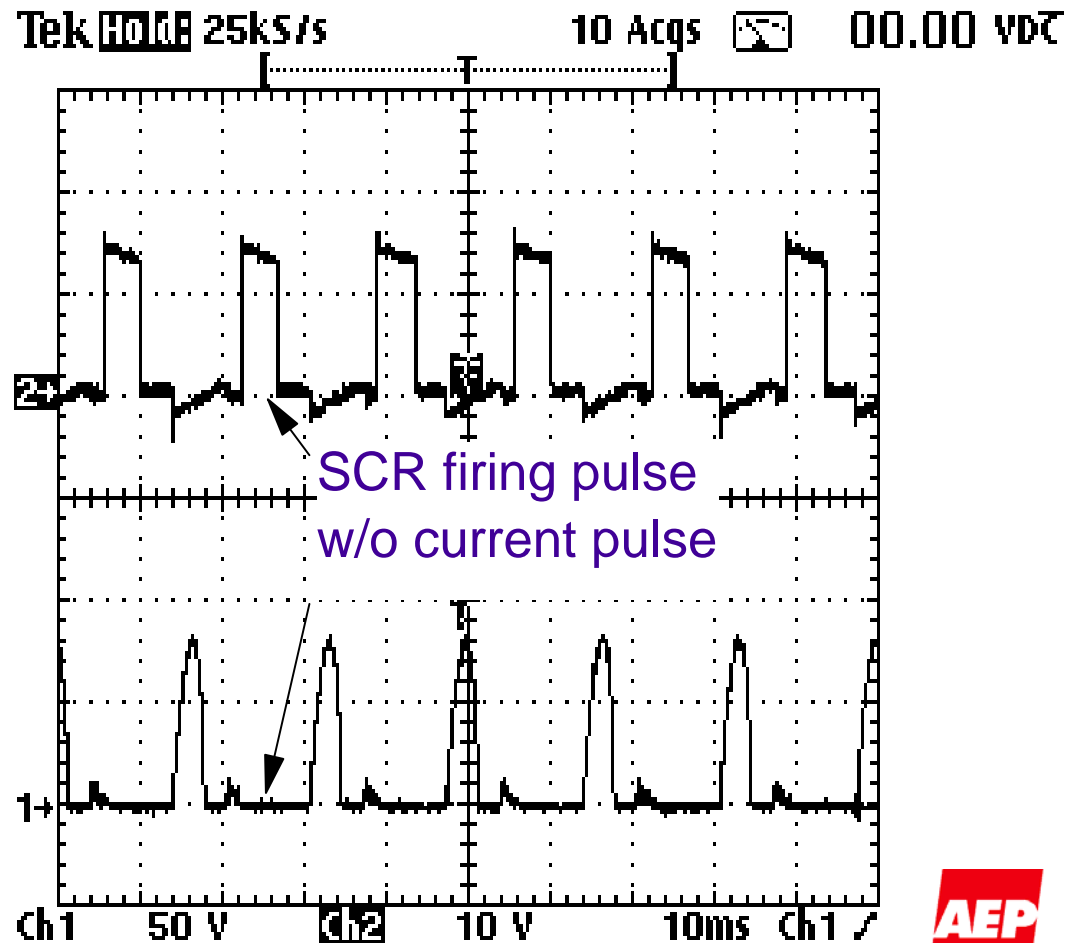

SCR Firing with Respect to Zero Crossing

An SCR, once gated (turned on) continues to be gated (flows current) until current flow stops. In an AC circuit current flow stops when the direction of current changes. Since the SCR are utilized on the AC portion of the controls circuit, TR set controls have an input for the AC feed to determine when current flow passes through zero on the direction change. This signal, because of its reference to current passing through zero, is known as “Zero Crossing”. The control bases its firing of the SCRs off of the Zero Crossing reference.

The SCRs are turned on by a series of pulses to their gates. The control establishes a buffer zone between Zero Crossing and the firing pulses, whether it fires early or late into the half cycle. This buffer zone is to ensure that the SCRs are always firing before the half cycle reaches Zero Crossing. If the SCR firing pulses occur while going through Zero Crossing, the SCR associated with the next half cycle will immediately fire. This will result in high, unwanted current flow which increases the voltage rapidly thus creating a major spark in the bus section.

Late Firing

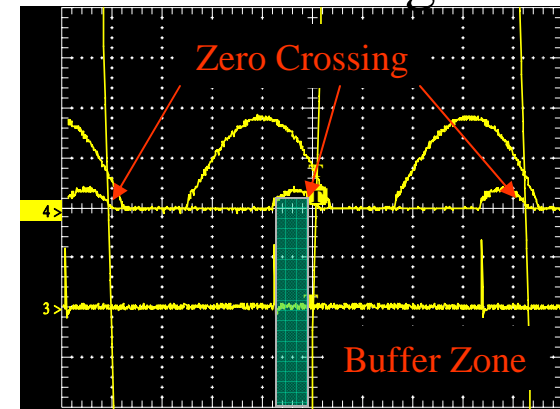

Early Firing

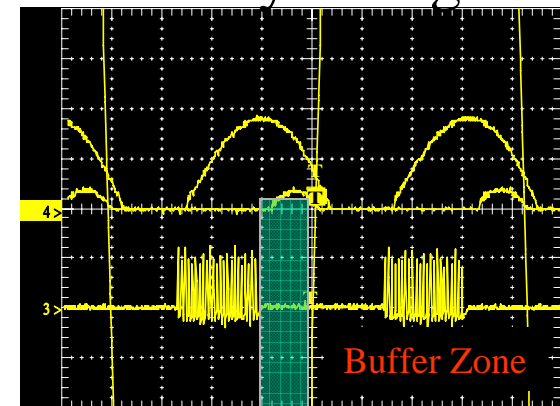

Ringings on Dual Bushing TRs if chokes are after cross-tie

The waveforms are traces of the secondary voltage and current. The significance of this trace is that ringing (a continuance of a spark) is occurring after the spark. The ringing occurs because inductive chokes are installed downstream of the full wave link between bushing on a dual bushing TR set.

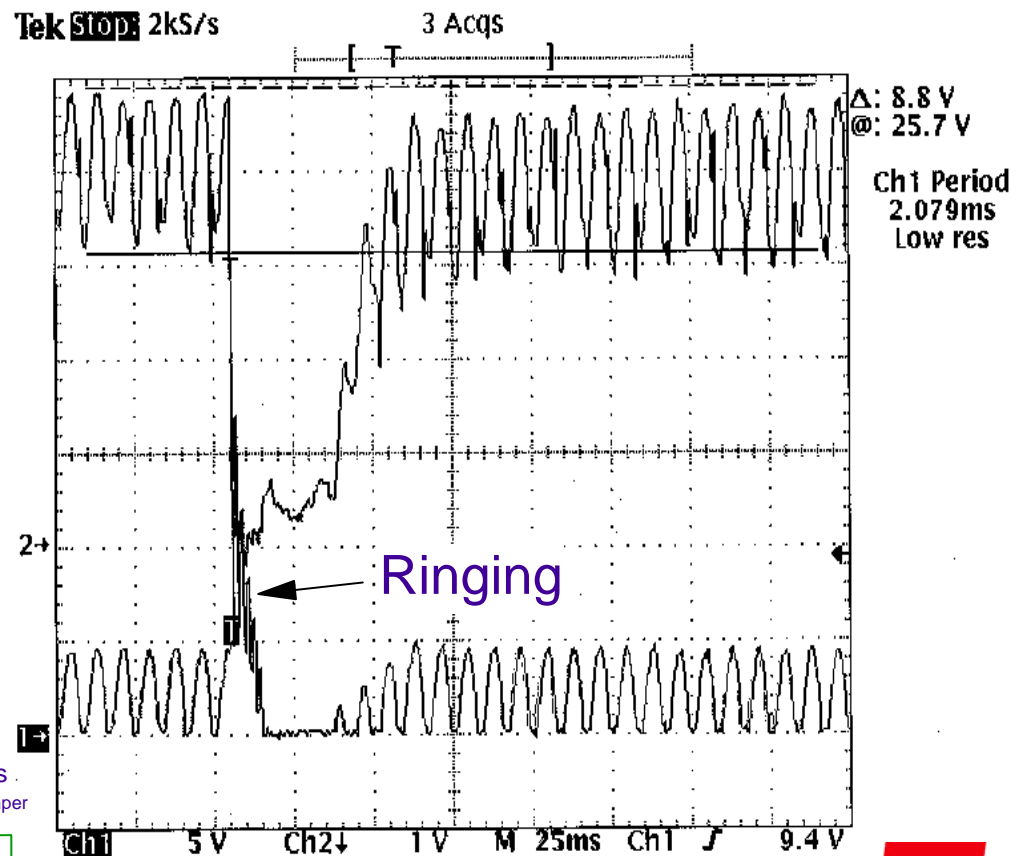
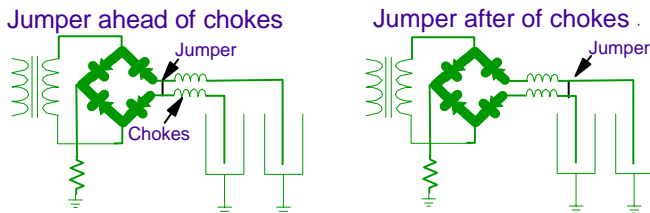

Spark Sensing Circuit Detecting A Spark

The waveforms are traces of the spark sensing circuit and the secondary current. When a spark occurs the capacitor in the sensing circuit holds the signal through a long discharge so sparks are not missed. This ensures a spark (because it is narrow) is not missed during the digital sampling of the current wave form.

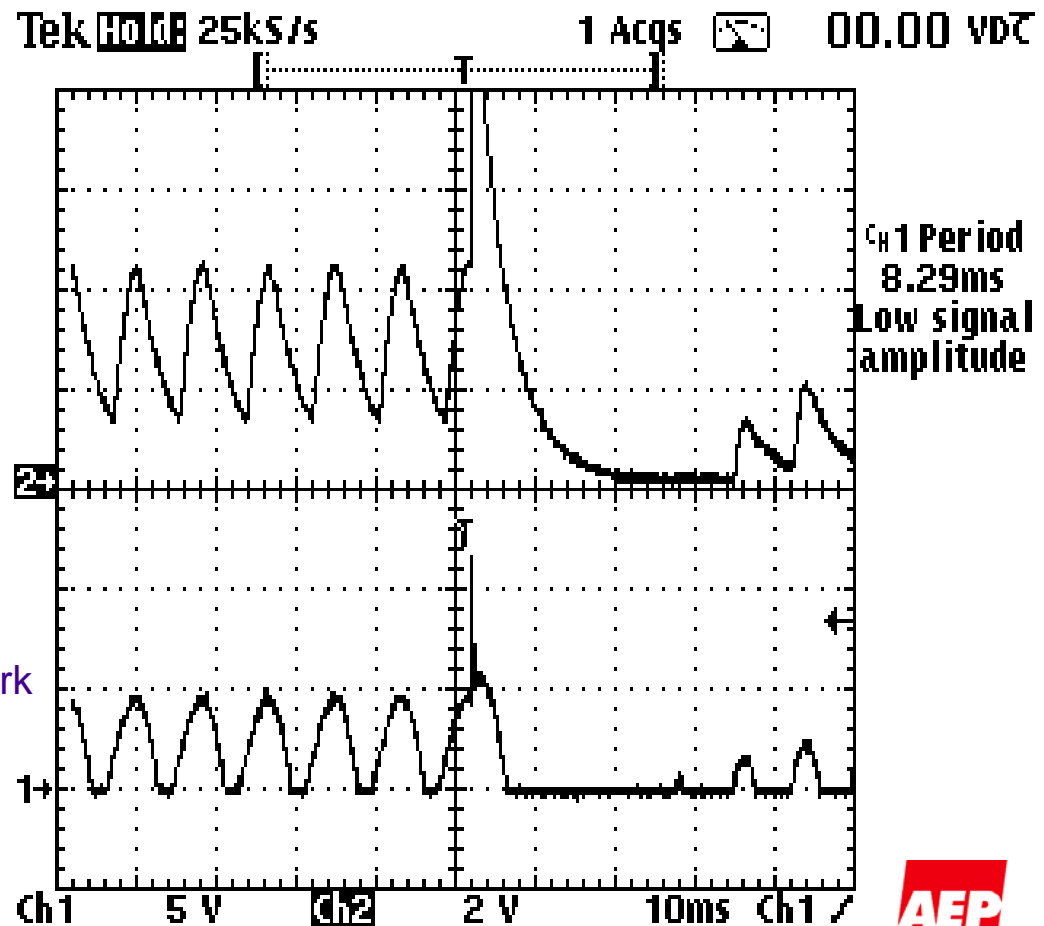
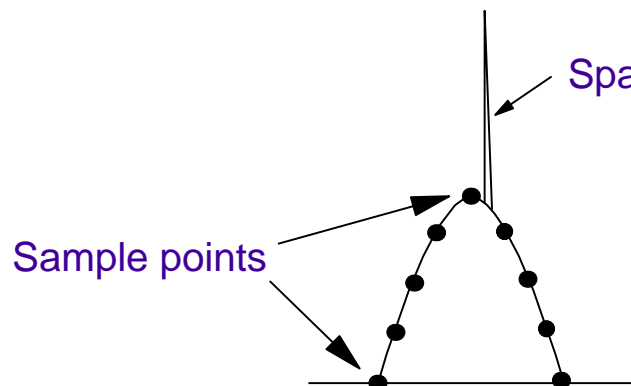

Suspect Diode Stack

The waveforms are traces comparing the secondary current of reference T/R set versus suspect T/R set. With reference set powered down to equal the output of suspect set. The wave form indicates that the on-time and peaks are about the same therefore the CLR should be OK. The edges of the SCR firing are not at 90° therefore the diode stacks may be going soft.

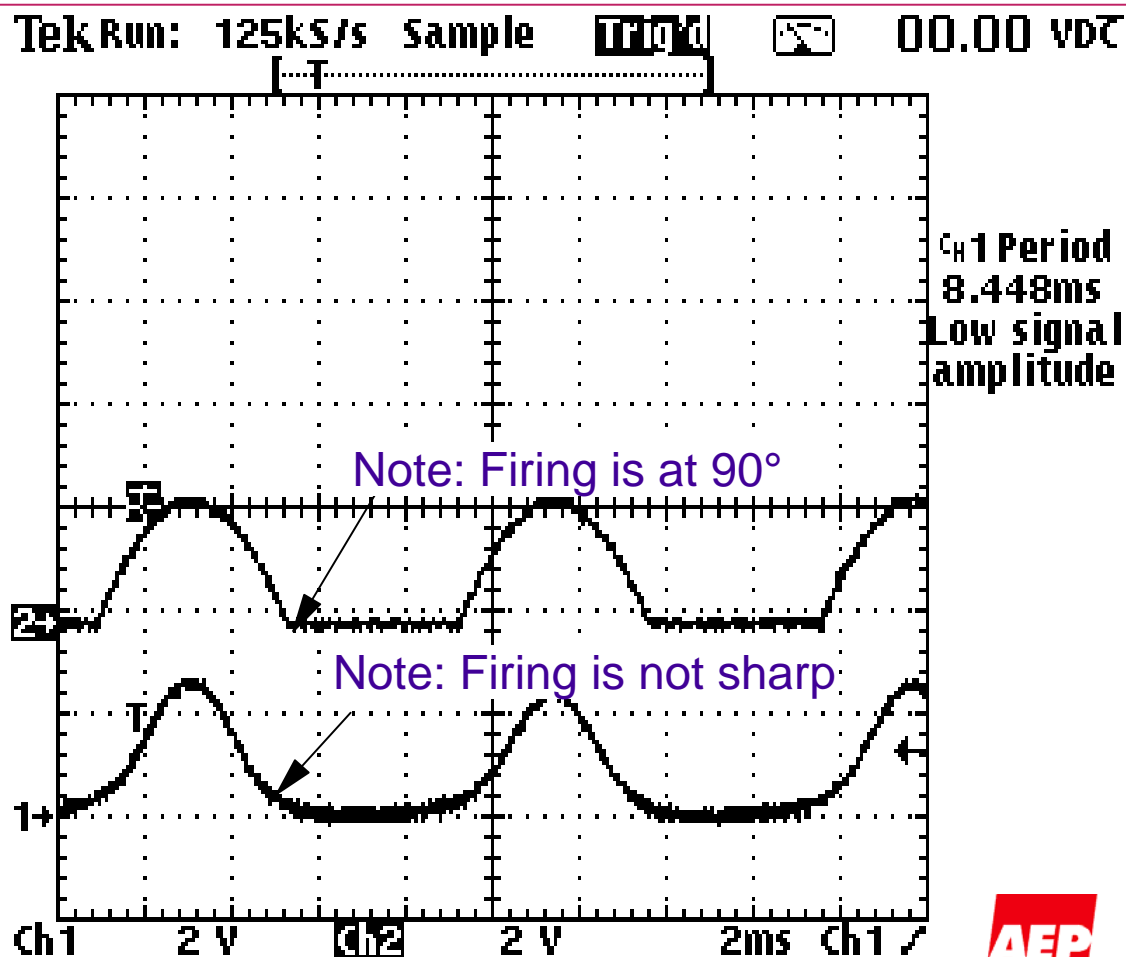

Suspect Current Limiting Reactor

The waveforms are traces comparing the secondary current of reference T/R set versus suspect T/R set. With reference set powered down to equal the output of suspect set, the waveform indicates that the on-time is shorter than the reference bus section and peaks are higher. The RMS appears to be a bit higher than the reference section. The CLR is suspect. The edges of the SCR firing are at 90° therefore the diode stacks should be OK.

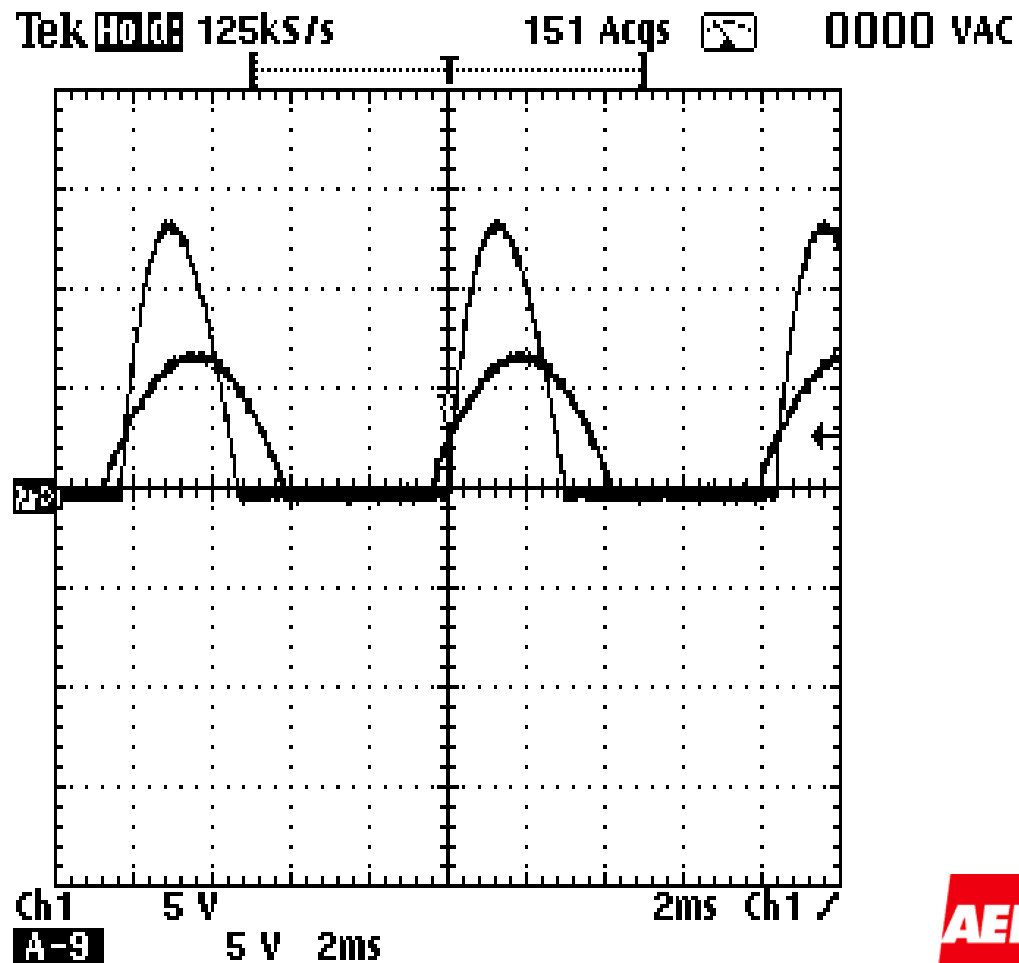

Suspect Current Limiting Reactor

The waveforms are traces comparing the secondary current of reference T/R set versus suspect T/R set. With reference set powered down to equal the output of suspect set, the wave form indicates that the on-time is longer than the reference bus section and peaks are lower. The RMS appears to be about the same therefore the CLR is suspect. The edges of the SCR firing are at 90° therefore the diode stacks should be OK.

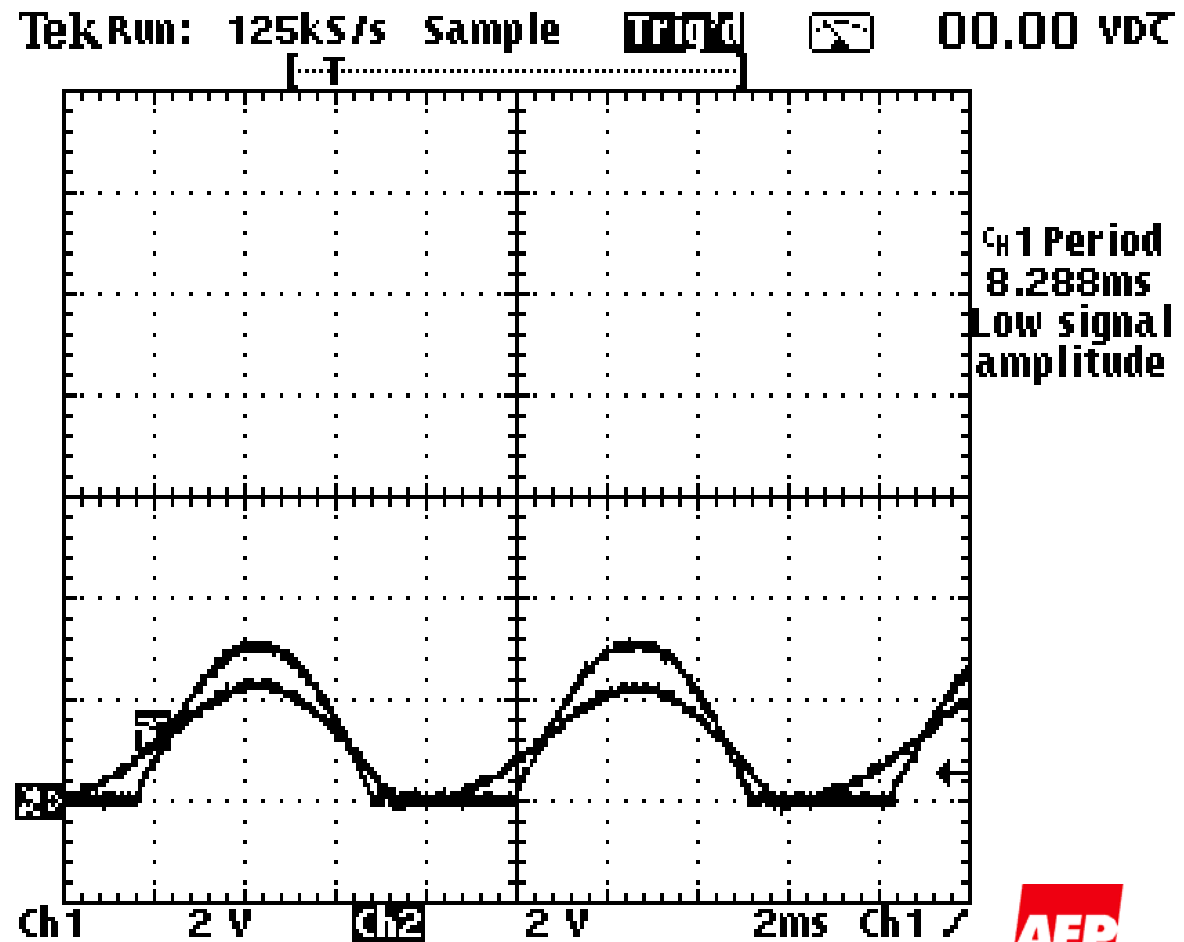

PRO SERVSM

Flue Gas Chemical Interaction



Russ Ridgeway - AEPSC



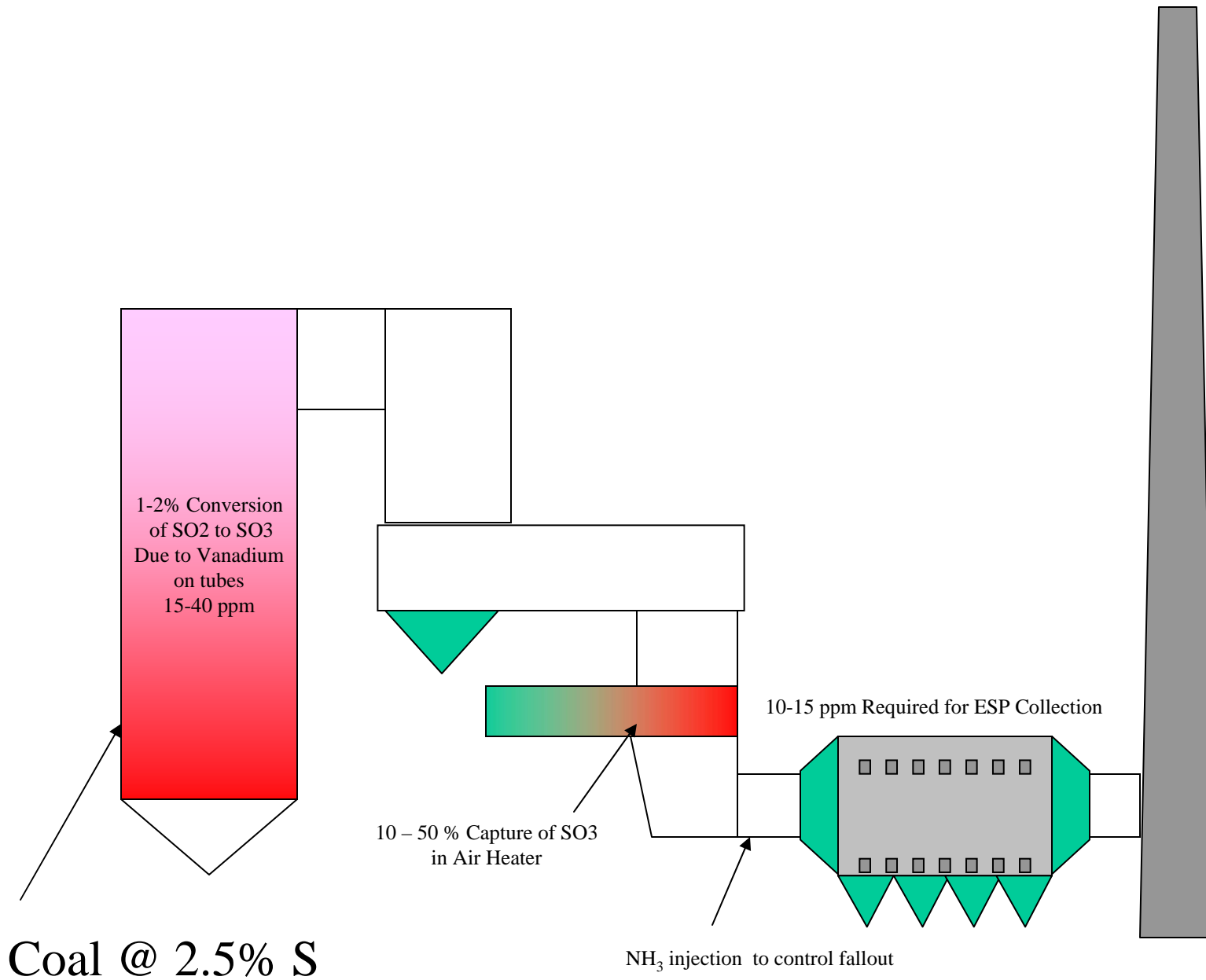

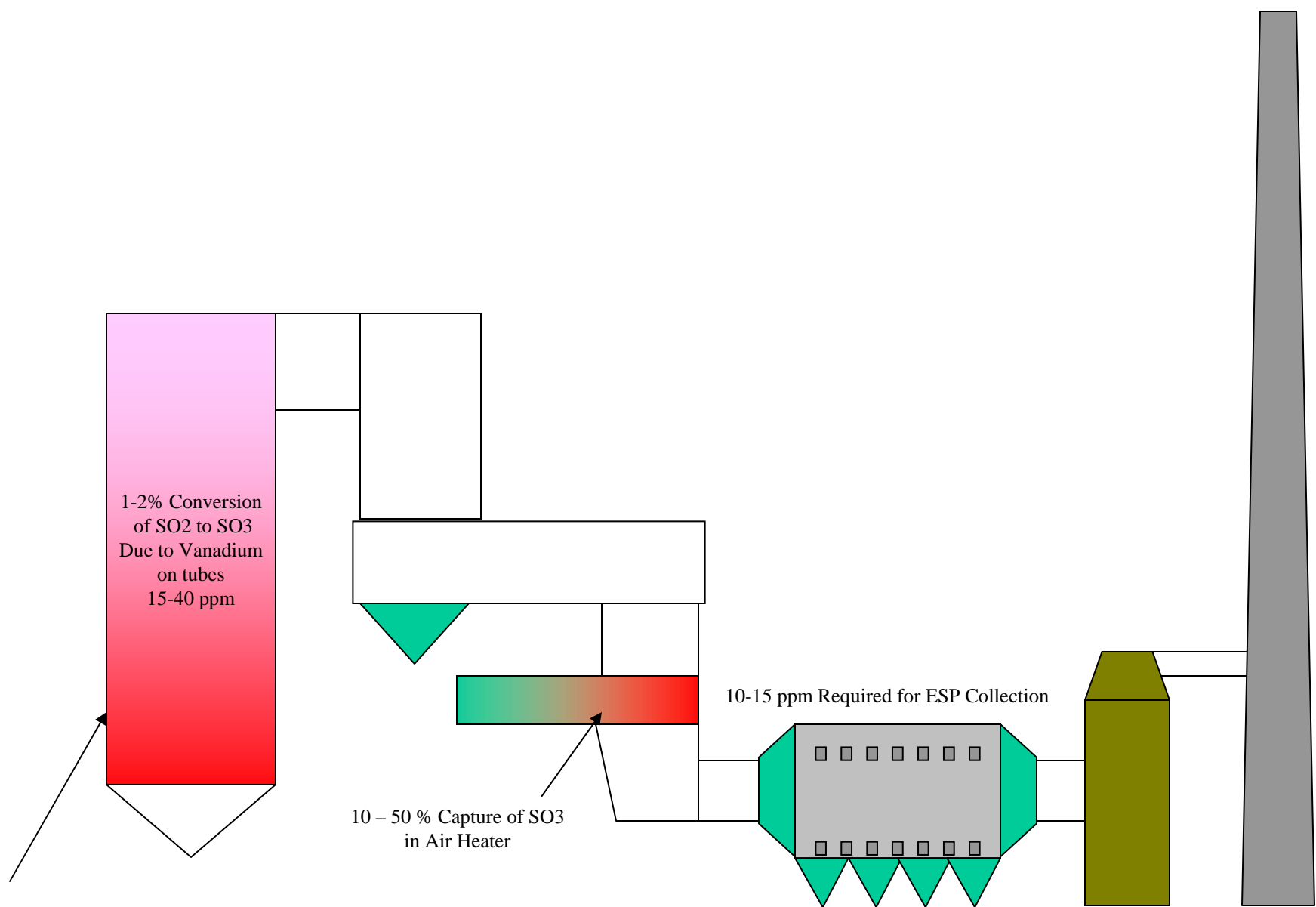

1-2% Conversion
of SO₂ to SO₃
Due to Vanadium
on tubes
15-40 ppm

10 – 50 % Capture of SO₃
in Air Heater

10-15 ppm Required for ESP Collection

Coal @ 2.5% S

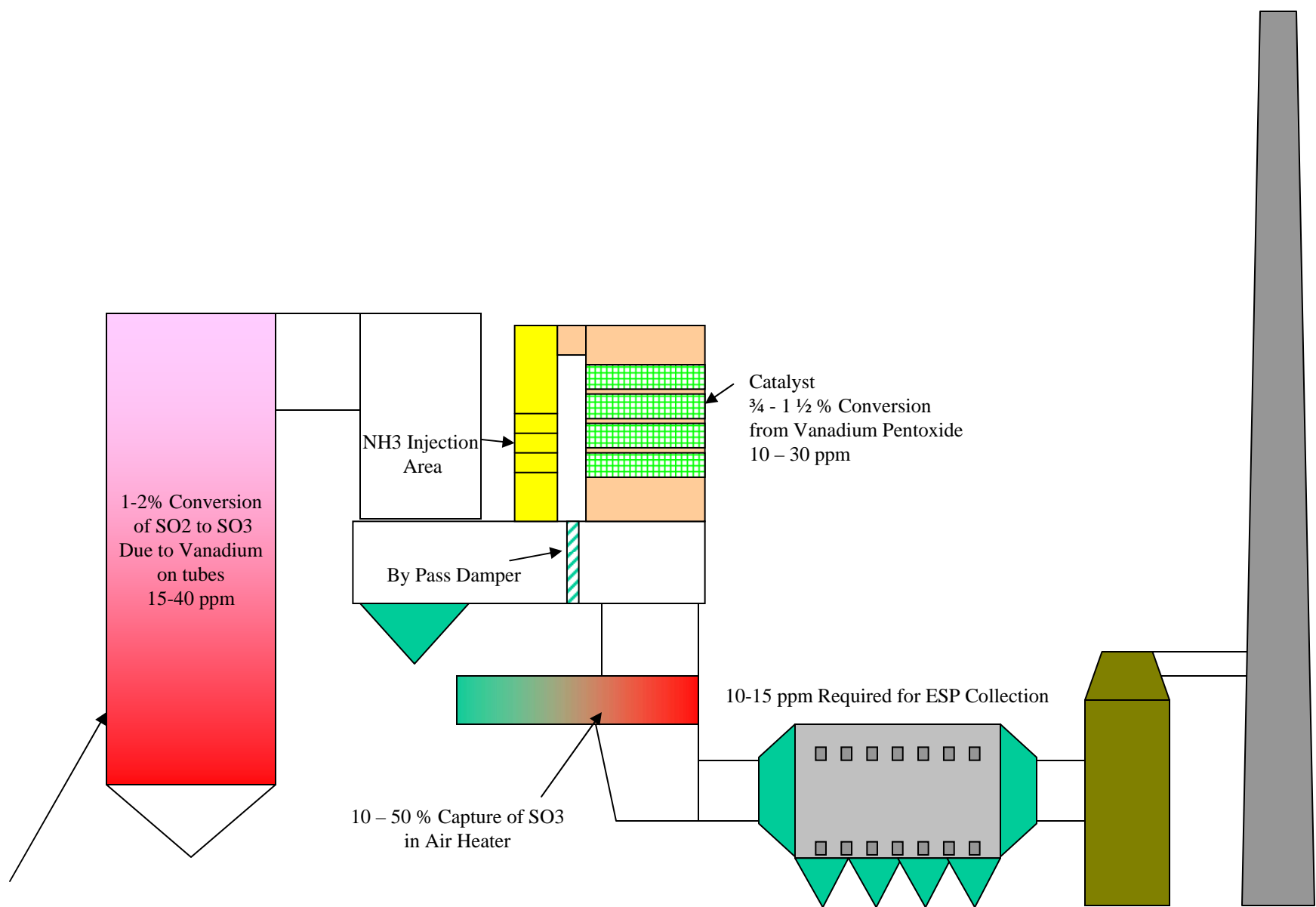

Coal @ 2.5% S